



# Energy Saving & Airtight

INNOVATIVE SOLUTIONS FOR A SUSTAINABLE WORLD





### **BOSTIK, SMART ADHESIVES**

The new logo and the new house style with the characteristic green gecko is more than just a visual appearance. "Smart Adhesives" is a reflection of our positioning with regard to the development of smart and innovative sealing and bonding solutions that are safe, flexible and efficient.

We develop innovative sealing and bonding solutions that, whatever is constructed, connected or built, are smarter and can adjust better to the forces and challenges in our daily life.

### **THE GECKO - INSPIRING ADHESION**

For centuries, scientists have been inspired by geckos because of their unique bonding mechanism. They can stick to almost any surface, can climb super-fast against smooth polished glass and can easily carry their entire body weight with just one toe.

The Bostik gecko is flexible, easy to adapt to environments, is open to new situations and is courageous. It symbolizes Bostik's smart and innovative sealing and bonding solutions for the challenges which today's market faces.

# 1. Introduction

### **Innovative solutions**

In 1889, the Boston Blacking Company, a producer of leather colourings and dyes for the shoemaking industry, was founded in Chelsea, Massachusetts. Over the last 130+ years, some transitions and mergers later, Bostik grew into a multinational owning over 9,000.

Bostik is an Arkema company. Arkema considers patents as a strategic pillar in its growth strategy and its contribution to sustainable development. The group innovates to develop products and solutions and continually improve their performance. Innovation relies on commercial excellence to anticipate on market trends and to develop the products today that the company's customers will need tomorrow.

### **Corporate Social Responsibility**

One of the commitments of our company's corporate social responsibility is the reduction of our environmental footprint. The Group decided to realise its sustainable development commitments by setting

out four new objectives for 2030 primarily translating it to resolve and reduce its environmental footprint and boost its operational excellence:

- Climate change: reduce its greenhouse gas emissions by 38% (with 2015 as the baseline)
- Air: reduce its volatile organic compounds emissions by 65% (with 2012 as the baseline)
- Water: reduce its chemical oxygen demand emissions by 60% (with 2012 as the baseline)
- Energy: reduction by 20% of net energy

### **A tool to oversee the environmental performance: the EFPIs**

The environmental performance of the Arkema group is steered with a high precision. Intensive indicators called EFPI have been created to calculate the most accurately the group's environmental footprint. These intensive indicators also called indicators of intensity and their calculation are audited by an independent third party body.



# Be Smart & Care



## Contents



2.	<b>The 17 Goals of The United Nations</b>	page 6
3.	<b>Passive House</b>	page 8
4.	<b>The Concept</b>	page 10
5.	<b>Explanations</b>	page 12
6.	<b>Certifications</b>	page 15
7.	<b>Application areas</b>	page 16
8.	<b>Portfolio</b>	page 18
8.1	<b>Compression Tapes</b>	page 19
8.2	<b>Foils</b>	page 23
8.3	<b>PU-Foam, coating &amp; adhesives</b>	page 26
9.	<b>Product selector</b>	page 30
10.	<b>Explanation of the icons</b>	page 32
11.	<b>Technical Training</b>	page 34

# 2. The 17 Goals of The United Nations



## Make cities inclusive, safe, resilient and sustainable\*

The world is becoming increasingly urbanized. Since 2007, more than half the world's population has been living in cities, and that share is projected to rise to 60 per cent by 2030.

Cities and metropolitan areas are powerhouses of economic growth—contributing about 60 per cent of global GDP. However, they also account for about 70 per cent of global carbon emissions and over 60 per cent of resource use.

In a fast-changing world characterized by global warming, a rising world population and urbanization, the emergence of new technologies, the increasing difficulty in accessing energy and safe drinking water, and the growing scarcity of certain resources, manufacturing companies like Bostik must constantly innovate and adapt their product range to offer solutions addressing these challenges.

\* Sources  
[www.un.org/sustainabledevelopment](http://www.un.org/sustainabledevelopment)  
[www.arkema.com](http://www.arkema.com)



## Bostik

We committed ourselves to support the program '17 Goals to transform our world', of The United Nations, where we have possibilities to contribute. The UN Sustainable Development Goals are a call for action by all countries – poor, rich and middle-income – to promote prosperity while protecting the planet. For Bostik, we have set ourselves the goals that will have an impact on delivering usable, innovative and environmentally friendly solutions in such areas as bio-based products, new energies, water management, electronics solutions, lightweight materials and design, and home efficiency and insulation.

### Good health and well-being (3)

Bostik heavily invests in human and environmentally friendlier products. Products with extreme low emission to be able to offer product certifications such as the French VOC A+, EMICODE EC1 Plus and/or even the M1 Emission Classification of Building Materials. Products that are fit easily in the schemes of BREEAM and LEEDS, accordingly the Hea 02 Indoor Air Quality, ticking the boxes regarding volatile organic compound (VOC) emission levels.

### Affordable and clean energy (7)

Bostik and Arkema materials used in solar panels, wind turbine blades and electric batteries support society's transition to new energies.

## Sustainable cities and communities (11)

The world is becoming increasingly urbanized. Since 2007, more than half the world's population has been living in cities, and that share is projected to rise to 60 per cent by 2030. Cities and metropolitan areas are powerhouses of economic growth—contributing about 60 per cent of global GDP. However, they also account for about 70 per cent of global carbon emissions and over 60 per cent of resource use. With the products of Bostik's concept Energy Saving & Airtight, we can limited amount of effort strongly reduce the carbon emissions expels and in parallel even strongly reduce the energy consumption per building up to 90 per cent.

### Responsible consumption and production (12)

In response to the decreasing supply of fossil resources, Bostik focuses its research efforts on renewable raw materials to produce green chemicals and bioplastics, which are more human and environmentally friendly. This way we protect the globe, you and our own employees.

### Climate action (13)

We take action! From lightweight packaging materials to solar power throughout the whole company. As example, the Sealing & Bonding training facility in the Netherlands is energy neutral and is producing such an amount of solar power, that all charging stations for electric cars at the premises of Oosterhout, are fed by our own produced energy.

# 3. Passive House



## Passive House

Already quite some years the phrase Passive House is all around us. But what is a passive house? Passive House is a building standard developed by Dr. Wolfgang Feist and Bo Adamson. A passive house is more than energy neutral or energy efficient. A passive house is truly energy efficient, comfortable and affordable at the same time.

A passive house can save energy for space heating/cooling up to 90% of a typical building and 75% compared to an average new building.

A passive house remains comfortable throughout the coldest winters and most beautiful summers. How? A passive house makes efficient use of sun, internal heat sources and heat recovery. Also the situation of the passive house on a building plot and the positioning of the highly efficient windows – including triple glazed units with warm edge spacers – are of strategic planning in the PHPP. Then the building envelop, the walls and roofs, is equipped with a premium insulation material to achieve optimum thermal insulation.

To assure and guarantee the high level of comfort, is where Bostik is joining the party. The portfolio in our application segment Energy Saving & Airtight, is specifically developed and carefully selected to assist all these mentioned above highly efficient building materials in keeping their promise. One of the key criteria in a passive house is keeping the desired warmth in the house, or undesirable heat out and avoid unpleasant draughts.

## Airtightness

All building elements comply with regulations. Also building elements in passive houses and energy-neutral buildings. In order to maintain the comfortable indoor climate (warm/cool), is to assure that the indoor climate is not able to escape to the outdoor climate. Otherwise we have to use a lot of energy to maintain the indoor climate. Using energy is not in our favour for the environment and for your wallet. So priority number one is to close all connections between all building elements and make them airtight. Within the Passive House Standard, airtightness has been brought to the next level. The requirement is that the building envelop should meet at least 0,60 ACH50. In other words, a maximum of 0,6 air changes per hour at a pressure of 50 Pa. So a building of 600 m<sup>3</sup> is allowed to let 360 m<sup>3</sup> air escape per hour.

## Thermal Insulation

Another well-known subject in the PHPP is the use of efficient insulation material. Having said that, if we have high-end building elements with an efficient thermal insulation contribution, 'joining' them together in the building envelop and only 'seal' the joint to make it airtight is not sufficient. We need to be sure that also the space between both adjacent building elements is offering an equally or higher thermal insulation value. We need to avoid any moisture entrapment due to an incorrect calculated dew point.

The products out of Bostik application segment Energy Saving & Airtight, that we recommend for the use of thermal insulation, all come with a thermal conductivity value at the technical datasheet. Thermal conductivity is declared in W/mK. But what is thermal conductivity and what can we do with it?

## Requirements

Thermal conductivity, denoted by  $\lambda$ , refers to the intrinsic ability of a material to transfer or conduct heat. It is one of the three methods of heat transfer, the other two being convection and radiation. Heat moves along a temperature gradient, from an area of high temperature and high molecular energy to an area with a lower temperature and lower molecular energy. This transfer will continue until thermal equilibrium is reached. The rate at which heat is transferred is dependent upon the magnitude of the temperature gradient, and the specific thermal characteristics of the material.

# 4. The Concept



## Onions

The concept of Energy Saving & Airtightness is like an onion. An onion is a vegetable made up of several layers. Each layer contributes to the whole onion and is protected by a dense skin, to protect the tasty vegetable. Freshly cut onions often cause uncontrollable tears in people's eyes. This is caused by the release of a volatile liquid, synpropanethial-S-oxide and its aerosol, which stimulates nerves in the eye.

The products in Bostik's application segment Energy Saving & Airtight should also be applied in different 'layers'. When the layers are installed incorrectly or if in the worst scenario no airtight product has been used, also uncontrollable tears appear in people's eyes. This will be because by the enormous increase of energy costs and there is a possibility that the construction can be damaged from the inside, with large, often financial consequences.



### Airtightness

Bostik's first layer in the concept is to close the façade at the inside airtight. This prevents a freely accessible and unwanted air flow from the colder external climate into a warm internal climate or vice versa.



### Thermal Insulation

The second layer in our concept is to focus at the energy efficiency of the house, thus the thermal insulation of the (connection) joint. The thermal insulation value of the joint must be at least at the same level of the adjacent building construction. We would like to prevent that the isothermal is transferred more at the inside of the building, compared to the prevailing (average) isothermal of the building (parts). This will prevent risk of condensation within the building envelop and possible water accumulation.



### Moisture Management

The last layer in our concept is to establish proper functional joints that prevents water load entering the construction. A water tight barrier must be created at the outside of our building envelop and by using the concept of pressure equalizing, water that does enter the façade should also be able to find its way out. A functionality that this barrier must have is permeability. Entrapped moisture should be able to be "breathe" to the outside.



### Sound Insulation

A bonus when all layers of the concept Energy Saving & Airtightness are functioning well together is the effect of a proper sound insulation. Within the Passive House guidelines, indoor comfort is not only meant for a convenient climate by means of temperature, but also refers to a quiet place where you feel at home and can relax!

# 5. Explanations



## Ventilation vs. Airtight

Ventilation of a building is necessary. Ventilation or air exchange in buildings occurs as a consequence of natural air infiltration and/or through the use of purpose ventilation systems. Ventilation caused by various openings in the building envelope, such as large openings around door and window frames, to small cracks and crevices caused by improper installation of envelope components, are called air infiltration and exfiltration.

This air infiltration and exfiltration is what we call air leakage and is something we don't want in a building. Air leakage has a considerable impact on the energy demand and the durability of the building. Besides the energy demand and durability, air leakages also affects indoor air quality. It introduces pollutants, allergens, and microbes into the building. This will influence the 'good health and well-being' of humans living/working in this building. Air infiltration can also result in moisture accumulation in the building envelope because airflow carries water vapour which condensate into water.

At Bostik we heavily advise for an airtight connection between building components. Airtight but vapour permeable, to avoid moisture accumulation in non-controllable and non-visible voids and spaces inside the building envelope. Bostik's portfolio for Energy Saving & Airtight, offers products that will support our philosophy of this concept. We offer also an Excel-tool where 20 most common building component connections are classified, Bostik's products can be chosen with a comparison of square meterage floor space of interior cubic meters building volume to discover the airloss change rate.

A 'rule of thumb' for this for this so called air leakage at 50 Pa pressure difference is:

$$Q_{inf} = Q_{50} / 20 \text{ (h}^{-1}\text{)}$$

Where:

- $Q_{inf}$  = infiltration rate per hour (h<sup>-1</sup>)
- $Q_{50}$  = air change rate @ 50 Pa

The requirement is that the building envelope should meet at least 0,60 ACH50. Of course it's voluntarily at low energy consuming and mandatory at passive house buildings, to do a blower door test. This device will give an average figure, based on 50 Pa underpressure and overpressure, of the air changing rate of the tested building. In the NZEB, Nearly Zero Energy Buildings – a new benchmark from the European Union started November 2019, dwellings should be 25% more energy efficient, allowing a maximum EPC of 0,4 and the upper limit for air permeability is between 3 and 5 m<sup>3</sup>/hr/m<sup>2</sup>!

## Water vapour

Water vapour is water in gaseous form and not liquid. Water vapour can be formed either by evaporation or sublimation. Water vapour is an invisible gas. This water vapour is an unwanted substance in the building envelope. The risk of water vapour is when it reaches the dew point, it will be turned into water. The dew point is the temperature to which air must be cooled to become saturated with water vapour. When cooled further, the airborne water vapour will condense to form liquid water.

Water vapour will 'travel' by diffusion from a high (vapour) pressured area to a low pressured surrounding. The medium that water vapour is using to 'travel' will resist this movement, meaning:

- Air,
- A 'certain thickness' of a solid material, or
- Tape and/or foil/membrane.

As architect, specifier or contractor of passive houses or NZEB, Nearly Zero Energy Buildings, you need to be aware of the moisture risk and how to control this in the building envelope.

So some products from our portfolio are equipped with a so called Sd-Value. An Sd-Value is a measure of how much resistance to moisture diffusion the medium has, when compared to a meter of air. It may also be known as "Diffusion-equivalent air layer thickness", or simply "Equivalent air layer thickness."

Depending on your global climate zone and during a winter and summer period, the principles of a 'water vapour safe' building envelop, is to understand how water vapour 'travels' on the building.

Butyl and bitumen tapes with an aluminium carrier come with a high Sd-Value (200m). If we place such a product on the cold side of the insulation, condensation will be a huge risk. This is exactly what you are witnessing when condensation forms on a window in winter. The glass has a very high Sd value, as its impermeable. Bostik M630 TAPE'N'TIGHT FOIL INTERIOR comes with a Sd-value of more than 10m. Bostik M640 TAPE'N'TIGHT FOIL EXTERIOR comes with a Sd-value of 0.05m and can be seen as a permeable (breathable) membrane.

A lower Sd-Value is desirable to achieve a permeable, but yet air tight connection. In general, the 'warm side' of the construction should be 5 times more moisture and water vapour resistant compared to the 'cold side' of the construction. By using the 'standard guideline' moisture can't be imprisoned inside the building envelop. By applying this recommendation, the risk of structural damage, mould growth, insufficient insulation values and performance, corrosion, etc. will be minimized.

The membranes in Bostik's portfolios are equipped with a Sd-Value. However, other products meant for thermal insulation can influence positively and negatively the resistance of water vapour. Although not equipped with a Sd-value, we are able to calculate the resistance by using the  $\mu$ -value. The  $\mu$ -value is the vapour diffusion resistance, the resistance offered by a material to the transmission of vapour.

#### Example:

'I need, beside my permeable membrane, to insulate the connection between my window frame and the building construction'. The joint depth of the window frame is 100 mm and the Bostik P605 FOAM'N'FILL FLEX AIRSTOP PRO is equipped with an  $\mu$ -value of 36 $\mu$ .

#### Calculation:

- o Sd-Value =  $\mu$ -value x thickness (m)
- o Sd-Value = 36 x (100/1000)
- o Sd-Value = 36 x 0.1 = 3.6 m

#### Result:

Bostik P605 FOAM'N'FILL FLEX AIRSTOP PRO is permeable for water vapour but yet one of the flexible polyurethane foams with the highest resistance against airloss available in the market.

#### Thermal conductivity

Similar as water vapour, warmth will also 'travel'. This heat flow is an inevitable consequence of contact between objects or areas with different temperatures. For all, but in specific for high efficient and low energy buildings, not only a controlled airtightness and water vapour, a proper thermal insulation is a priority as well. When (high-end) building components with (high) thermal insulation have been brought together in the building envelop, the connection joints are most likely to be forgotten to insulate as well. When these connection joints between two high efficient thermal insulating building components, aren't enough insulated, the change of the isothermal can assure that the dew point will occur inside the joint cavity with the risk of condensation and thus water accumulation.

The multi-function compression tapes Bostik M610 TAPE'N'TIGHT TAPE 2D and Bostik M620 TAPE'N'TIGHT TAPE 3D as well as our polyurethane foams do come with a tested thermal conductivity value. But what is thermal conductivity and what can we do with it?

The lambda value ( $\lambda$ ) indicates the thermal conductivity of a material. It is expressed in W/mK. The higher the value, the better the heat is conducted and thus the less the material insulates. We can use the thermal conductivity and the thickness of the material to calculate the heat resistance of the structure. The heat resistance or also thermal resistance is a heat property and a measurement of a temperature difference by which an object or material resists a heat flow.

#### Example:

'Besides the water vapour resistance, I also need to understand the amount of polyurethane foam I need to apply in this joint between my window frame and the building construction'.

The joint depth of the window frame is 100 mm and the Bostik P605 FOAM'N'FILL FLEX AIRSTOP PRO is equipped with an  $\lambda$ -value of 30 mW/m.K.

#### Calculation:

- R = heat resistance in m<sup>2</sup> K/W
- d = thickness of the material in m
- $\lambda$  = thermal conductivity in W/mK
- o R = d /  $\lambda$
- o R = 0.1/0.030
- o R = 3,3 m<sup>2</sup>K/W

#### Correct dimensions

In chapter 6 we explain the regulations and guidelines regarding the selection and use of compression tapes. Accordingly the DIN 18542:2009, we completely explain how to choose the correct joint width but also the most optimum joint depth. Of course, we can also offer you a tool where you can select your current situation and the actual joint dimensions, so the tool will provide you the most suitable compression tape dimensions including the article codes, which you can use when you place the order.

## 6. Certifications

The new Bostik Energy Saving & Airtight range complies to many well-known industry standard certifications. Below we highlight and explain all the certifications in more detail.

#### GEV-EMICODE EC1 Plus

EMICODE® is a protected product classification system and at the same time an Eco label. Installation materials, adhesives and construction materials are submitted to a strict certification procedure where the quantity of emitted volatile organic compounds (VOC) is examined. When products come with the EC1 Plus certification, they can be easily adapted in the BREAAAM and LEED schemes.

#### BREEAM\*

BREEAM is the world's leading sustainability assessment method for master planning projects, infrastructure and buildings. It recognises and reflects the value in higher performing assets across the built environment lifecycle, from new construction to in-use and refurbishment.

BREEAM does this through third party certification of the assessment of an asset's environmental, social and economic sustainability performance, using standards developed by BRE. This means BREEAM rated developments are more sustainable environments that enhance the well-being of the people who live and work in them, help protect natural resources and make for more attractive property investments.

Source [www.breeam.com](http://www.breeam.com)

#### Products

Products can't be BREEAM certified, however certified products can be used in the BREEAM assessment rating. Bostik products can be used in BREAAAM's chapter #2, Health and Wellbeing.

#### Indoor air quality

Exposure to air pollutants can have a significant detrimental impact on human health. Poor indoor air quality is likely to contribute to Sick Building Syndrome. Products equipped with EMICODE EC1 Plus and products fulfilling the Finnish Building Classification System M1, will fit in this assessment rating as they have an extremely low or no VOC expels.

#### Thermal Comfort

Being uncomfortably hot or cold can lead to adverse effects on performance, and extreme temperatures can lead to heat exhaustion or hypothermia. High relative humidity can cause the proliferation of mould, leading to respiratory illness and allergies. Products in this brochure Energy Saving & Airtightness, will support the thermal comfort as well as the solution against mould growth due to condensation/moisture build up near door and window frames.

#### Acoustic comfort

The potential effects of noise include hearing impairment, disturbance of sleep and rest, anxiety, stress, and general annoyance. Products in this brochure Energy Saving & Airtightness and Expanding Foams, will support also this topic in the BREEAM assessment rating.



# 7. Application areas



**BOSTIK P605 FOAM'N'FILL FLEX AIRSTOP PRO**  
Flexible thermal insulating and airtight polyurethane gun foam.

See page 28 for more details.



**BOSTIK A630 FOIL'N'FIX INTERIOR**  
High grip water based interior membrane adhesive

See page 29 for more details.



**BOSTIK T630 TAPE'N'TIGHT WINDOW FOIL INTERIOR**  
Premium flexible airtight interior window foil

See page 24 for more details.



**BOSTIK H670 AIRSTOP COATING**  
Sprayable and brushable airtight coating

See page 28 for more details.



**BOSTIK M620 TAPE'N'TIGHT TAPE 3D**  
Multi-functional vapour variable, thermal and sound insulating and rainresistant joint sealing tape

See page 22 for more details.



**BOSTIK M650 TAPE'N'TIGHT WINDOW FOIL AIRTIGHT**  
Airtight self-adhering vapour permeable membrane

See page 25 for more details.



**BOSTIK M610 TAPE'N'TIGHT TAPE 2D**  
Multi-functional thermal insulating and airtight joint sealing tape

See page 21 for more details.



**BOSTIK M600 TAPE'N'TIGHT TAPE BG1**  
Impregnated polyurethane foam joint sealing tape

See page 20 for more details.



**BOSTIK H640 FOIL'N'FIX EXTERIOR**  
Premium strong hybrid membrane adhesive for interior and exterior applications

See page 29 for more details.



**BOSTIK M640 TAPE'N'TIGHT WINDOW FOIL EXTERIOR**  
Premium flexible and vapour permeable exterior window foil

See page 24 for more details.

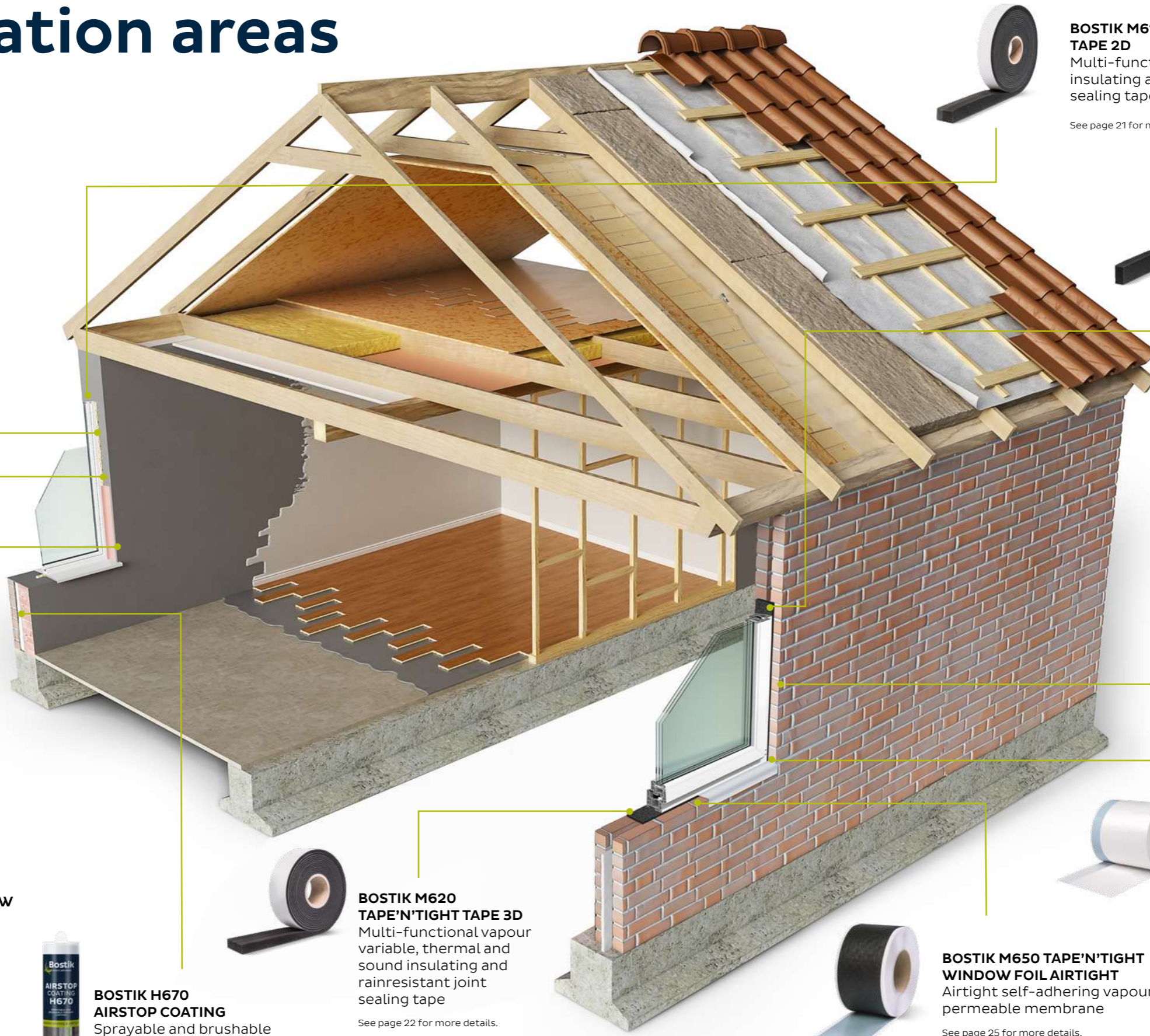

# 8. Portfolio

## 8.1 Compression Tapes

### Guidelines

I have a joint width of 10 mm on my drawing. How to choose the correct tape dimension, both tape width and depth?

The recommendation of Bostik would be to choose the **BOSTIK M600 TAPE'N'TIGHT BG1 XX/7-12**, because this one is capable of a joint width from 7 till 12 mm.

### A. Determine the correct tape width

The nominal value is the value mentioned at the architectural drawings. For example see the drawing below. The joint width is 10 mm. Theoretically a **BOSTIK M600 TAPE'N'TIGHT BG1 15/5-10** could be applied, because of the extension '5-10'. However...

### Options for 7-12:

- 15/7-12 : joint depth 15 mm
- 20/7-12 : joint depth 20 mm
- 30/7-12 : joint depth 30 mm

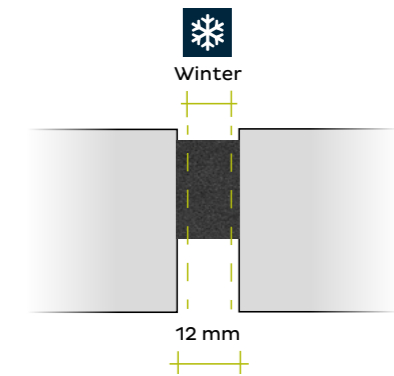
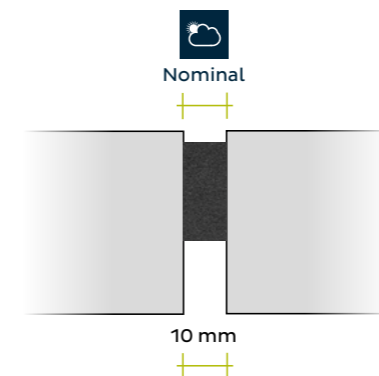

... in the summer period, see the drawing below, the adjacent building elements will elongate due to heat absorption. The joint will compress from 10 till 8 mm. The **BOSTIK M600 TAPE'N'TIGHT BG1 15/5-10** could still be the preferred dimension to apply, however...

### B. Determine the correct tape depth

The calculation how to determine the correct tape depth/height is as follow:

- Depth =  $bo \times \frac{1}{2}$
- Depth =  $12 \times 5 \times \frac{1}{2} = 30 \text{ mm}$

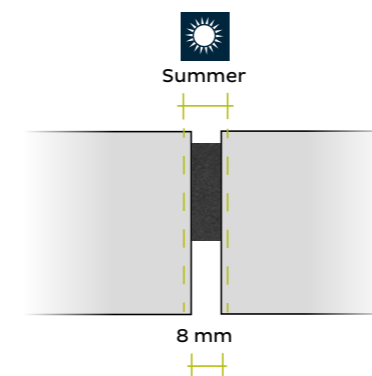

... in the winter period the adjacent building elements will decrease in length due to colder temperatures. The joint will expand from 10 till 12 mm. The **BOSTIK M600 TAPE'N'TIGHT BG1 15/5-10** cannot perform properly. UV-stability and rain resistance will cause problems.



### BOSTIK M600 TAPE'N'TIGHT TAPE BG1

Impregnated polyurethane foam joint sealing tape



#### Product description

BOSTIK M600 TAPE'N'TIGHT TAPE BG1 is an impregnated pre-compressed polyurethane foam joint sealing tape with soft foam with acrylate dispersion impregnation, accessory agents and filling agents. BOSTIK M600 TAPE'N'TIGHT TAPE BG1 is a one sided adhesive. After application the pre-compressed tape will expand slowly to fill the joint. At a compression of at least 30% of the maximum width the impregnated foam is watertight against driving rain up to 600 Pa.

#### Most important characteristics

- Resistant to a wind pressure of 1050 Pa against driving rain
- Long-term weather-resistant
- Joint sound insulation RST,W max. 59 dB
- Thermal conductivity  $\lambda=0.0421$  W/mK
- Diffusion open
- Building materials class B1
- Weather resistant in the long term

#### Certificates

- Emicode EC1 Plus
- BRL 2802
- KOMO
- SKH
- A+ French VOC Regulation



### BOSTIK M610 TAPE'N'TIGHT TAPE 2D

Multi-functional thermal insulating and airtight joint sealing tape



#### Product description

BOSTIK M610 TAPE'N'TIGHT TAPE 2D is a pre-compressed and impregnated multifunction joint-sealing tape. It is used to seal airtight areas, and for thermal and sound insulation in window joint seals in a single product.

#### Most important characteristics

- 1 Product for airtight and thermal insulation
- Meets requirements of BG-R
- Airtightness  $a_n < 0,1$  m<sup>3</sup>/h·m
- 2 Colours for easy application
- Joint sound insulation RST,W max. 53 dB
- Thermal conductivity  $\lambda=0,0428$  W/mK
- Building materials class B2

#### Certificates

- EN 1026
- EN 1027
- EN 12667
- DIN 18542
- Emicode EC1 Plus



Joint width	Reference code	Joint depth	Min. joint width UV and rain resistance	Max. Joint width UV and rain resistance	Completely Uncompressed	Packaging m1 per roll	Packaging m1 per box
2 mm	10/1,5-2,5 15/1,5-2,5 20/1,5-2,5	10 mm 15 mm 20 mm	1,5 mm	2,5 mm	10 mm	12,5 12,5 12,5	375,0 250,0 187,5
2 - 4 mm	10/2-4 15/2-4 20/2-4	10 mm 15 mm 20 mm	2 mm	4 mm	20 mm	10,0 10,0 10,0	300,0 200,0 150,0
3 - 7 mm	10/3-7 15/3-7 20/3-7	10 mm 15 mm 20 mm	3 mm	7 mm	35 mm	8,0 8,0 8,0	240,0 160,0 120,0
5 - 10 mm	10/5-10 15/5-10 20/5-10 30/5-10	10 mm 15 mm 20 mm 30 mm	5 mm	10 mm	50 mm	5,6 5,6 5,6 5,6	112,0 84,0 67,2 56,0
7 - 12 mm	15/7-12 20/7-12 30/7-12	15 mm 20 mm 30 mm	7 mm	12 mm	60 mm	4,3 4,3 4,3	86,0 64,5 43,0
8 - 15 mm	20/8-15 25/8-15	20 mm 25 mm	8 mm	15 mm	75 mm	3,3 3,3	49,5 39,6
10 - 18 mm	20/10-18 25/10-18 30/10-18	20 mm 25 mm 30 mm	10 mm	18 mm	90 mm	2,6 2,6 mto	31,2 26,0 mto
12 - 25 mm	25/12-25	25 mm	12 mm	25 mm	125mm	mto	mto
20 - 35 mm	35/20-35	35 mm	20 mm	35 mm	175 mm	mto	mto

Joint width	Window frame depth 60 mm	Window frame depth 70 mm	Window frame depth 80 mm	Window frame depth 90 mm	Function Area min. joint width	Function Area max joint width
4 - 9 mm	56/4-9	64/4-9	74/4-9	84/4-9	4 mm	9mm
6 - 15 mm	56/6-15	64/6-15	74/6-15	84/6-15	6 mm	15 mm
10 - 20 mm	56/10-20	64/10-20	74/10-20	84/10-20	10 mm	20 mm
15 - 30 mm	56/15-30	64/15-30	74/15-30	84/15-30	15 mm	30 mm

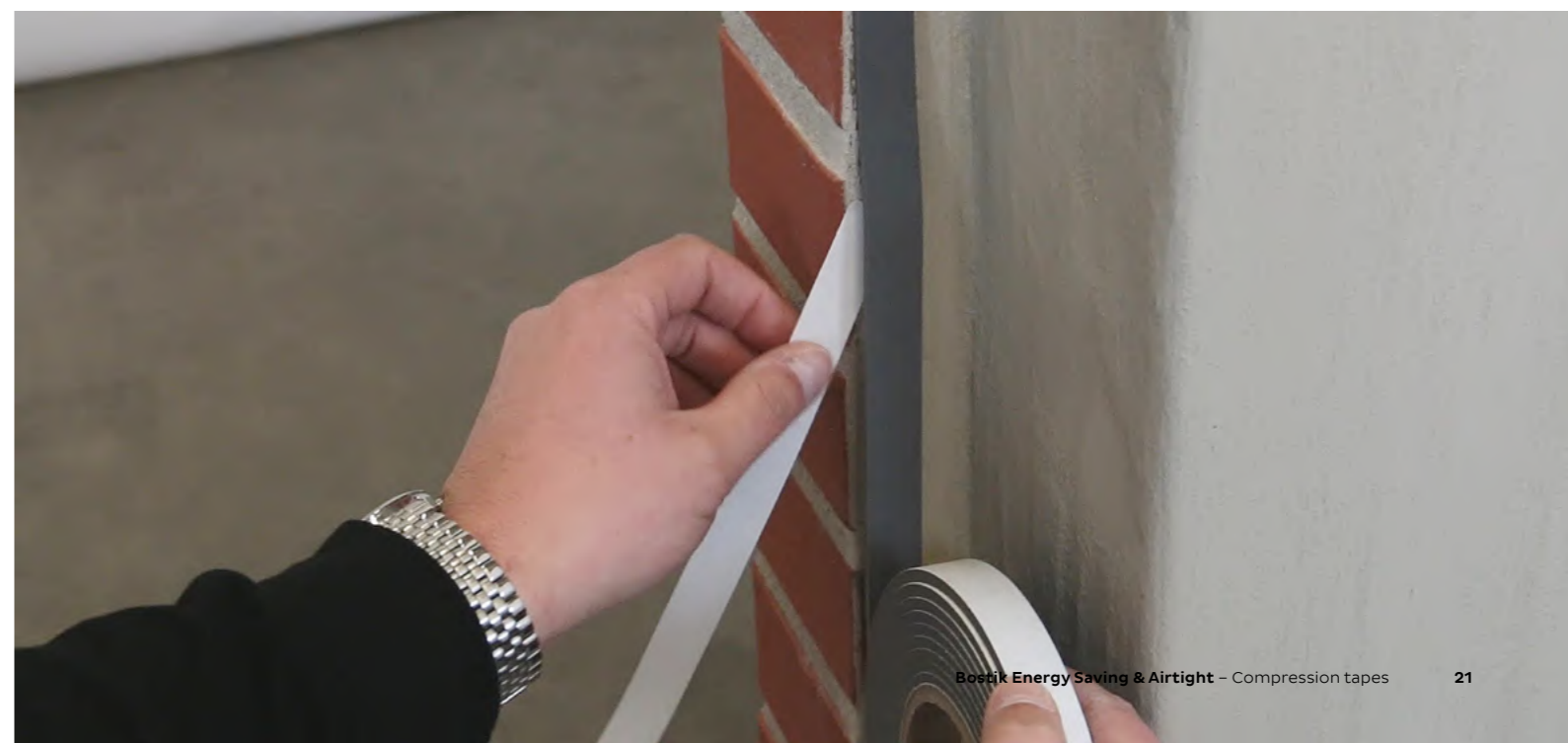

### BOSTIK M620 TAPE'N'TIGHT TAPE 3D

Multi-functional vapour variable, thermal and sound insulating and rain resistant joint sealing tape



#### Product description

BOSTIK M620 TAPE'N'TIGHT TAPE 3D is a multi-function vapour variable joint sealing tape for airtightness, thermal and sound insulation and heavy, driving rain resistance in one single product.

#### Most important characteristics

- One product for airtight, thermal and sound insulation and heavy, driving rain resistance
- Tested till 1050 Pa
- Meets requirements of BG-R
- Joint sound insulation R<sub>ST,W</sub> max. 57 dB
- Thermal conductivity  $\lambda=0,0428$  W/mK
- Building materials class B2
- Airtightness  $a_n < 0,1$  m<sup>3</sup>/h·m

#### Certificates

- EN 12114
- EN 1027
- EN 12667
- DIN 18542
- Ecode EC1 Plus)



Joint width	Window frame depth 60 mm	Window frame depth 70 mm	Window frame depth 80 mm	Window frame depth 90 mm	Function Area min. joint width	Function Area max joint width
4 - 9 mm	56/4-9	64/4-9	74/4-9	84/4-9	4 mm	9 mm
6 - 15 mm	56/6-15	64/6-15	74/6-15	84/6-15	6 mm	15 mm
10 - 20 mm	56/10-20	64/10-20	74/10-20	84/10-20	10 mm	20 mm
15 - 30 mm	56/15-30	64/15-30	74/15-30	84/15-30	15 mm	30 mm

## 8.2 Foils

#### Guidelines

The choice of FOIL WIDTH must correspond to the maximum joint width that needs to be sealed. Take in account the area of application where movement (can) occur due to mechanical and thermal stress.

In general, with fully bonded films, a minimum adhesion to the substrate of at least 50 mm and a mutual overlap of at least 25 mm applies.

#### Preparation

The substrates to adhere should be as flat as possible and thoroughly cleaned. Porous bonding substrates must be prepared with the Primer B&B Universal. When priming, make sure the surface is dry. Apply the primer maximum 30 to 40 mm wider than the adhesive surface of the foil. Waiting time after application of primer until the processing of a film is at least 30-60 minutes. The consumption of the Primer B&B Universal is approximately 200 ml/m<sup>2</sup>.

Before applying the Bostik M630 TAPE'N'TIGHT WINDOW FOIL INTERIOR, Bostik M640 TAPE'N'TIGHT WINDOW FOIL EXTERIOR and/or Bostik M650 TAPE'N'TIGHT WINDOW TAPE AIRTIGHT, which are equipped with adhesive and a release paper, non-porous substrates must be cleaned with the Bostik Cleaner.

#### Application

If there has been a drying time of more than 60 minutes between application of primer and foil, wipe off the dust with a soft cloth or dustpan before applying the foil. Use the detachable protective foil to prevent the foil from sticking completely to the substrate. Try to process maximum lengths of 1 meter at a time in order to apply the film tightly and flat. Always apply films without tension!

#### Frame anchors (mechanical fixing)

Bostik advises when using BOSTIK M650 TAPE'N'TIGHT WINDOW TAPE AIRTIGHT or butyl tapes, always to 'patch' the concerns and anchors first. Longer lengths can subsequently be processed more simply, more efficiently and faster.

#### Corner details

Always install internal and external corner details tension-free and in a tile-like manner. When meeting critical connections in the corners, use a "patch" to ensure air and water tightness.

#### Patching

This is the so-called "healing", the sticking of a band aid.

#### Pinch roller

Use the pinch roller to roll over the foil to obtain a good bond between product and substrate.

#### Bonding Window Foils

It is a deliberate choice that the window foils only have a 25 mm wide adhesive strip. Depending on the detail, the craftsman can choose how to bond the film (direction).

Bostik recommends the following bonding

**BOSTIK M630 TAPE'N'TIGHT WINDOW FOIL INTERIOR** With BOSTIK A630 FOIL'N'FIX INTERIOR or BOSTIK H640 FOIL'N'FIX EXTERIOR

**BOSTIK M640 TAPE'N'TIGHT WINDOW FOIL EXTERIOR** With BOSTIK H640 FOIL'N'FIX EXTERIOR

#### UV Resistance

Cover the window foils within 3 months after application the avoid deterioration by UV.

#### Storage

The shelf life is 12 months from the production date. Store in the original packaging in a cool and dry place at temperatures between + 5 ° C and + 25 ° C. Keep the box upright (rolls lying flat).



### BOSTIK M630 TAPE'N'TIGHT WINDOW FOIL INTERIOR

Premium flexible airtight interior window foil

#### Product description

BOSTIK M630 TAPE'N'TIGHT FOIL INTERIOR is an airtight, tear-proof, highly flexible fleece fabric, with an integrated self-adhesive affixing strip. For interior applications. BOSTIK M630 TAPE'N'TIGHT FOIL INTERIOR can be bonded with both BOSTIK H640 FOIL'N'FIX EXTERIOR and BOSTIK A630 FOIL'N'FIX INTERIOR.

#### Most important characteristics

- Installation without additional film adhesive
- Airtightness  $an \leq 0.1 \text{ m}^3/\text{h}\cdot\text{m}$
- $sD$  value  $> 10 \text{ m}$
- Slit release paper
- Can be plastered/rendered over
- Flexible/Stretchable
- Suitable for renovation and new construction

#### Certificates

- EN 1027
- Ecode EC1 Plus

Packaging	Packed per	Colour
50 mm x 30 m <sup>2</sup> /rol	8 rolls per box	pink
75 mm x 30 m <sup>2</sup> /rol	5 rolls per box	pink
100 mm x 30 m <sup>2</sup> /rol	4 rolls per box	pink
150 mm x 30 m <sup>2</sup> /rol	2 rolls per box	pink
200 mm x 30 m <sup>2</sup> /rol	2 rolls per box	pink
250 mm x 30 m <sup>2</sup> /rol	1 rolls per box	pink

### BOSTIK M640 TAPE'N'TIGHT WINDOW FOIL EXTERIOR

Premium flexible and vapour permeable exterior window foil

#### Product description

BOSTIK M640 TAPE'N'TIGHT FOIL EXTERIOR is a vapour diffusion-open, tear-proof, superior fleece fabric, with an integrated self-adhesive affixing strip for exterior applications. Can be bonded with BOSTIK H640 FOIL'N'FIX EXTERIOR.

#### Most important characteristics

- Vapour-permeable nonwoven material combination
- Can be plastered and painted
- Elastic to absorb movement in adjacent substrates
- Integrated self-adhering strip
- For connections sealed against driving rain  $\geq 600 \text{ Pa}$
- Waterproof in accordance with DIN EN 13984 W1
- UV resistant for 3 months

#### Certificates

- EN 1027
- Ecode EC1 Plus

Packaging	Packed per	Colour
50 mm x 30 m <sup>2</sup> /rol	8 rolls per box	white
75 mm x 30 m <sup>2</sup> /rol	5 rolls per box	white
100 mm x 30 m <sup>2</sup> /rol	4 rolls per box	white
150 mm x 30 m <sup>2</sup> /rol	2 rolls per box	white
200 mm x 30 m <sup>2</sup> /rol	2 rolls per box	white
250 mm x 30 m <sup>2</sup> /rol	1 rolls per box	white
300 mm x 30 m <sup>2</sup> /rol	1 rolls per box	white

### BOSTIK M650 TAPE'N'TIGHT WINDOW FOIL AIRTIGHT

Airtight self-adhering vapour permeable membrane

#### Product description

BOSTIK M650 TAPE'N'TIGHT FOIL AIRTIGHT is an airtight, vapour permeable and self-adhesive membrane for air and water tight connections between façades elements and supporting structures with a water based adhesive and a protective release paper.

#### Most important characteristics

- Installation without additional adhesive(s)
- For driving rain tight connections  $\geq 600 \text{ Pa}$
- Watertight acc. to DIN EN 13984 W1
- 12 months resistance to ultraviolet radiation
- Can be plastered/rendered
- Permeable to water vapour
- Applicable at low temperatures

#### Certificates

- EN 1026
- EN 1027
- EN 1931
- Ecode EC1 Plus

Packaging	Packed per	Colour
75 mm x 50 m <sup>2</sup> /rol	5 rolls per box	black
100 mm x 50 m <sup>2</sup> /rol	4 rolls per box	black
150 mm x 50 m <sup>2</sup> /rol	2 rolls per box	black
200 mm x 50 m <sup>2</sup> /rol	2 rolls per box	black
250 mm x 50 m <sup>2</sup> /rol	1 rolls per box	black





## 8.3 PU-foam, coating & adhesives

### Extensive portfolio

The new Bostik Energy Saving & Airtight portfolio consists of tapes and foils but also contains some excellent other energy saving products such as PU-foam, coatings and two adhesives.

### Airtight foam

The BOSTIK P605 FOAM'N'FILL FLEX AIRSTOP PRO is specifically developed for creating airtight and thermally insulated joints around window frames. The permanent flexibility creates a sustainable and highly insulating (airtight) seal. BOSTIK P605 FOAM'N'FILL FLEX AIRSTOP PRO is tested according to EN1026 for air loss at 1050Pa and has excellent adhesion, durable sealing functions with high insulation values.

BOSTIK P605 FOAM'N'FILL FLEX AIRSTOP PRO can be used in combination with the foils and tapes in the Energy Saving & Airtight segment or separately if required. Also suitable in construction, partition walls, ceiling and floor joints, surface penetration of pipes and tubes through walls and floors. Ideal for use in Passive Housing and energy neutral buildings.

### Coating

Bostik also has a special coating available in its Energy Saving & Airtight segment. This special coating is airtight and extremely suitable for use in Passive Housing and energy neutral buildings. BOSTIK H670 AIRSTOP COATING was specifically developed as a coating for durable elastic sealing of seams and cracks between various construction parts. Can also be used as a coating for the automotive and transport industry for repairing damages in the original structure. BOSTIK H670 AIRSTOP COATING is a high quality durable elastic sprayable and brushable coating for seamlessly sealing seams and cracks between various substrates.

### Adhesives

The Energy Saving & Airtight portfolio has two kinds of adhesives available. BOSTIK A630 FOIL'N'FIX INTERIOR is a waterbased foil and membrane adhesive suitable for interior use. The product has high grip properties and is extremely suitable in combination with BOSTIK M630 TAPE'N'TIGHT FOIL INTERIOR.

The second adhesive in the Energy Saving & Airtight portfolio is a hybrid based adhesive. This adhesive is a premium strong hybrid membrane adhesive for interior and exterior applications. BOSTIK H640 FOIL'N'FIX EXTERIOR is a high modulus foil and membrane adhesive with extreme low emissions and can be used in combination with BOSTIK M630 TAPE'N'TIGHT FOIL INTERIOR and BOSTIK T640 TAPE'N'TIGHT WINDOW FOIL EXTERIOR.





### BOSTIK P605 FOAM'N'FILL FLEX AIRSTOP PRO

Flexible thermal insulating and airtight polyurethane gun foam

#### Product description

BOSTIK P605 FOAM'N'FILL FLEX AIRSTOP PRO is an one component professional flexible thermal and sound insulation B3 polyurethane foam providing an extreme low airloss.

#### Most important characteristics

- Extreme low air loss, most air tight foam available on the market and tested till 1050 Pa
- Flexible formulation, applicable in joints with high movement
- Provides great sound reduction
- High yield
- Excellent adhesion properties
- Highly certificated
- Perfect fit with Bostik window membranes

#### Certificates

- EN 1026 & EN 12114
- EN 12086 Water vapour transmission
- EN 1609 Water vapour patial immersion
- ISO 10534 - Sound absorption coefficient
- DIN 12354-3 Joint Sound Insulation
- DIN 18542 Air Permeability
- Emission EC1 Plus
- A+ French VOC Regulation

Packaging	Packed per	Colour
750 ml canister	12 cans per box	white



### BOSTIK H670 AIRSTOP COATING

Sprayable and brushable airtight coating

#### Product description

BOSTIK H670 AIRSTOP COATING is high quality durable elastic sprayable and brushable airtight coating for seamlessly sealing seams and cracks between various substrates.

#### Most important characteristics

- Extreme low air loss and tested till 1050 Pa
- Seamless and fast sealing of all shapes and connections
- Fast, clean and easy to use
- Can be modelled with a brush
- Free of isocyanate and silicones
- Fast curing
- Permanently elastic

#### Certificates

- EN 1026
- EN 1027
- A+ French VOC Regulation

Packaging	Packed per	Colour
290 ml cartridge	12 cartridges per box	white and grey



### BOSTIK A630 FOIL'N'FIX INTERIOR

High grip water based interior membrane adhesive

#### Product description

BOSTIK A630 FOIL'N'FIX INTERIOR is a high grip water based foil and membrane adhesive.

#### Most important characteristics

- Water based high initial tack foil grab adhesive
- Solvent free
- Suitable for bonding EPS and XPS
- Paintable with water based- and synthetic paints
- Perfect adhesion without the use of a primer, even on slightly damp substrates
- Fast and clean applicable
- Perfect fit with Bostik window membranes

#### Certificates

- Emission EC1 Plus
- A+ French VOC Regulation

Packaging	Packed per	Colour
300 ml cartridge	12 cartridges per box	white



### BOSTIK H640 FOIL'N'FIX EXTERIOR

Premium strong hybrid membrane adhesive for interior and exterior applications

#### Product description

BOSTIK H640 FOIL'N'FIX EXTERIOR is a high modulus hybrid based foil and membrane adhesive with very low emission.

#### Most important characteristics

- Free of isocyanates, solvents and silicones
- Adheres perfectly without primer on most surfaces
- High modulus
- UV, weather and water resistant
- Durable, permanent elastic
- No shrinkage
- High flexibility and durability

#### Certificates





- A+ French VOC Regulation

Packaging	Packed per	Colour
290 ml cartridge	12 cartridges per box	grey



# 9. Product selector



Product	   				Certificates
	Airtight	Thermal Insulation	Rain Resistance	Sound Insulation	
<b>BOSTIK M600</b> <b>TAPE'N'TIGHT TAPE BG1</b>			<input checked="" type="checkbox"/>	<input checked="" type="checkbox"/>	- EMICODE EC1 PLUS - BRL 2802 - KOMO - SKH - A+ FRENCH VOC REGULATION
<b>BOSTIK M610</b> <b>TAPE'N'TIGHT TAPE 2D</b>	<input checked="" type="checkbox"/>	<input checked="" type="checkbox"/>		<input checked="" type="checkbox"/>	- EN 1026 - EN 1027 - EN 12667 - DIN 18542 - EMICODE EC1 PLUS
<b>BOSTIK M620</b> <b>TAPE'N'TIGHT TAPE 3D</b>	<input checked="" type="checkbox"/>	<input checked="" type="checkbox"/>	<input checked="" type="checkbox"/>	<input checked="" type="checkbox"/>	- EN 12114 - EN 1027 - EN 12667 - DIN 18542 - EMICODE EC1 PLUS
<b>BOSTIK M630</b> <b>TAPE'N'TIGHT WINDOW FOIL INTERIOR</b>	<input checked="" type="checkbox"/>		<input checked="" type="checkbox"/>		- EN 1027 - EMICODE EC1 PLUS
<b>BOSTIK M640</b> <b>TAPE'N'TIGHT WINDOW FOIL EXTERIOR</b>	<input checked="" type="checkbox"/>		<input checked="" type="checkbox"/>		- EN 1027 - EMICODE EC1 PLUS
<b>BOSTIK M650</b> <b>TAPE'N'TIGHT WINDOW TAPE AIRTIGHT</b>	<input checked="" type="checkbox"/>		<input checked="" type="checkbox"/>		- EN 1026 - EN 1027 - EN 1931 - EMICODE EC1 PLUS
<b>BOSTIK P605</b> <b>FOAM'N'FILL FLEX AIRSTOP</b>	<input checked="" type="checkbox"/>	<input checked="" type="checkbox"/>		<input checked="" type="checkbox"/>	- EN 1026 & EN 12114 - EN 12086 WATER VAPOUR TRANSMISSION - EN 1609 WATER VAPOUR PATIAL IMMERSION - ISO 10534 - SOUND ABSORPTION COEFFICIENT - DIN 12354-3 JOINT SOUND INSULATION - DIN 18542 AIR PERMEABILITY - EMICODE EC1 PLUS - A+ FRENCH VOC REGULATION
<b>BOSTIK H670</b> <b>AIRSTOP COATING</b>	<input checked="" type="checkbox"/>		<input checked="" type="checkbox"/>		- EN 1026 - EN 1027 - A+ FRENCH VOC REGULATION
<b>BOSTIK A630</b> <b>FOIL'N'FIX INTERIOR</b>					- EMICODE EC1 PLUS - A+ FRENCH VOC REGULATION
<b>BOSTIK H640</b> <b>FOIL'N'FIX EXTERIOR</b>					- A+ FRENCH VOC REGULATION







#	Description	BOSTIK M600 TAPE'N'TIGHT TAPE BG-1	BOSTIK M610 TAPE'N'TIGHT TAPE 2D	BOSTIK M620 TAPE'N'TIGHT TAPE 3D
1.	Air leakage coefficient at 10 Pa in m <sup>3</sup> / (h·m·(daPa))	≤ 1,0	≤ 1,0	≤ 0,1
2.	Rain resistance at Δp, in Pa	≥ 600 Pa	≥ 300 Pa	-
3.	Rain resistance at cross section at Δp, in Pa	≥ 600 Pa	-	-
4.	Resistance against temperature fluctuations	Between -20°C and +80°C	Between -20°C and +80°C	Between -20°C and +80°C
5.	Resistance against light and humidity fluctuations	Guaranteed	-	-
6.	Compatible with adjacent materials	Up to +80°C	Up to +60°C	Up to +60°C
7.	Fire behavior (DIN4102-1)	B1	B2	B2
8.	S <sub>d</sub> -value in m	≤ 0,5	≤ 0,5	-





# 10. Explanation of the icons

The brand new packaging of the Energy Saving & Airtight range comes with icons that tell something about the properties of the product. Below we explain in detail what these icons mean.



- 
**Airtightness**  
 The product complies with airtightness in the Energy Saving & Airtight concept.
- 
**Moisture Management**  
 The product complies with Moisture Management in the Energy Saving & Airtight concept.
- 
**Thermal Insulation**  
 The product complies with Thermal Insulation in the Energy Saving & Airtight concept.
- 
**Sound Insulation**  
 The product complies with Sound Insulation in the Energy Saving & Airtight concept.
- 
**Outside & inside use**  
 The product can be used outside and inside.
- 
**Inside use**  
 The product can only be applied indoors.

- 
**Thermal shield**  
 The product has excellent thermal insulating properties.
- 
**No staining**  
 The product has excellent weather resistant properties.
- 
**Modelling with a brush**  
 The product can be modelled with a brush.
- 
**Applicable with a putty knife**  
 The product can be applied with a standard putty knife.
- 
**Gun grade foam**  
 The product is a PU-foam that must be used in combination with PU-guns.
- 
**Gloves**  
 Use gloves when handling the product.

- 
**UV resistance**  
 The product has an excellent resistance to UV.
- 
**Window installation**  
 The product is suitable for the installation of window frames.

- 
**Cutting time**  
 The product can be cut after 60 minutes curing time.

# 11. Technical Training

# Bostik professional product portfolio

The rest of the Bostik professional product portfolio you can find at [bostik.com](http://bostik.com) and read more about them in the product application brochures

End-users expect up-to-date knowledge and technical support from shop-employees. Bostik supports with training programs focusing on products and applications. We co-develop training programs with producers and resellers to combine the knowledge of energy saving with knowledge on dedicated Bostik products.



### Better results through Knowledge

Energy saving & Airtight are a serious market segment which deserves a dedicated approach. Bostik constantly gathers knowledge about energy saving upstream and downstream, from chemical supplier to end-user. The collection of this knowledge is a continuous process and provides us with the latest insights.

### Centre of Excellence

In our recently built Centre of Excellence we share knowledge within the Bostik group, with our customers and with end-users. We are pleased to receive our partners and end-users to provide them with the latest knowledge and new insights. This new information enables our partners to achieve higher efficiency and better results.





**Smart help**  
**+31 (0) 162 491 000**



**Bostik Benelux B.V.**  
P.O.Box 194, 4900 AD Oosterhout,  
The Netherlands  
Phone: + 31 (0)162 491 000  
E-mail: [info.benelux@bostik.com](mailto:info.benelux@bostik.com)  
[www.bostik.com](http://www.bostik.com)

#### Terms & Conditions

Bostik, S.A., its parent companies, subsidiaries and affiliated entities (collectively, "Bostik") offers this Brochure for descriptive and informational use only. The Brochure is not a contract and is not a substitute for expert or professional advice. The statements, technical information, data, and recommendations contained herein are not exhaustive, are believed to be accurate as of the date hereof, and are not warranted in any way. The Brochure relies upon your knowledge and input, and as such, its results are based solely upon the information you provide and the choices that you make. Since the conditions and methods of use of the products and the information referred to herein are beyond our control, Bostik expressly disclaims any and all liability and damages that may arise from any use of the Brochure, the products, the results therefrom, or reliance on the information contained herein, and you hereby agree to waive any and all claims against Bostik relating in anyway thereto. The Brochure is one of several tools that may be used to help you find the product best suited for your needs. It is used at your own risk, and by using it, you are knowingly accepting and assuming any and all risks associated with its use, recommendations, output and your selections. You are responsible to test the suitability of any product in advance for any intended use. Bostik does not guarantee the reliability, completeness, use, or function of the Brochure or any recommendations arising therefrom. The data and information contained in the Brochure is provided 'AS IS'.

The information provided herein relates only to the specific products designated and may not be applicable when such products are used in combination with other materials or in any process. Bostik encourages you to always read and understand (1) the Technical Data Sheet ("TDS") and (2) the Safety Data Sheet ("SDS") for all products before use. The SDS contains the necessary information related to prevention and safety related to the use of a product. The SDS for our products and the TDS for our products can be found on our corporate website. You are welcome and encouraged to contact your customer service representative to discuss your specific requirements and to determine what product is appropriate for you and your applications. NO WARRANTY OF FITNESS FOR ANY PARTICULAR PURPOSE OR WARRANTY OF MERCHANTABILITY, EXPRESSED OR IMPLIED, IS MADE CONCERNING THE PRODUCTS DESCRIBED OR THE INFORMATION PROVIDED HEREIN, AND SUCH WARRANTIES ARE HEREBY DISCLAIMED. Additionally, Bostik disclaims any liability for direct, incidental, consequential, or special damages to the maximum extent allowed by law. Nothing contained herein constitutes a license to practice under any patent, and it should not be construed as an inducement to infringe any patent. You are advised to take appropriate steps to be sure that any proposed use of the products will not result in patent infringement. Also, please see Arkema's Medical Device Policy at <https://www.arkema.com/en/social-responsibility/responsible-product-management/medical-device-policy/index.html>.

#### Acceptance of Terms & Conditions

By using this Brochure, you are hereby consenting to the above terms and conditions of use, and you agree to waive certain rights as set forth above.